

# SPECIFIKACE / SPECIFICATION / SPEZIFIKATION

   	<p><b>PMEC spol. s r.o.</b>                  nám. Republiky 8, 787 01 Šumperk, Czech Republic                  Phone/Fax 00420 583 216 582                  www.pmec.cz info@pmec.cz</p>
---	--

TYPOVÉ OZNAČENÍ / ARTICLE NUMBER / ARTIKELNUMMER	DATUM / DATE / DATUM
--	----------------------

<b>PMEC 102/Vi 1m2 3,0 A</b>	<b>2010-09-23</b>
------------------------------	-------------------

POPIS / DESCRIPTION / BEZEICHNUNG	
-----------------------------------	--

<p><b>Proudově kompenzované odrušovací tlumivky</b>  <b>Current-compensated noise suppression chokes</b>  <b>Stromkompensierte Funkentstördrosseln</b></p>	
--	---

ROZMĚRY (ZDOLA) / DIMENSIONS (FROM BELLOW) / ABMESSUNGEN (VON UNTEN)
--

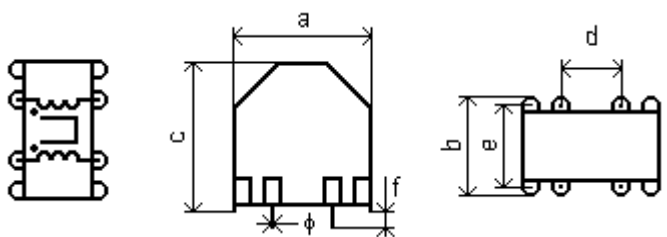
	<table border="1" style="width: 100%; border-collapse: collapse;"> <tr><td>a</td><td><b>23,5 max</b></td><td>mm</td></tr> <tr><td>b</td><td><b>16,0 max</b></td><td>mm</td></tr> <tr><td>c</td><td><b>25,5 ±0,2</b></td><td>mm</td></tr> <tr><td>d</td><td><b>10,0 ±0,2</b></td><td>mm</td></tr> <tr><td>e</td><td><b>12,5 ±0,2</b></td><td>mm</td></tr> <tr><td>f</td><td><b>3,0 ±0,5</b></td><td>mm</td></tr> <tr><td>g</td><td></td><td>mm</td></tr> <tr><td>φ</td><td><b>0,6 x 0,6 typ</b></td><td>mm</td></tr> </table>	a	<b>23,5 max</b>	mm	b	<b>16,0 max</b>	mm	c	<b>25,5 ±0,2</b>	mm	d	<b>10,0 ±0,2</b>	mm	e	<b>12,5 ±0,2</b>	mm	f	<b>3,0 ±0,5</b>	mm	g		mm	φ	<b>0,6 x 0,6 typ</b>	mm
a	<b>23,5 max</b>	mm																							
b	<b>16,0 max</b>	mm																							
c	<b>25,5 ±0,2</b>	mm																							
d	<b>10,0 ±0,2</b>	mm																							
e	<b>12,5 ±0,2</b>	mm																							
f	<b>3,0 ±0,5</b>	mm																							
g		mm																							
φ	<b>0,6 x 0,6 typ</b>	mm																							

ELEKTRICKÉ VLASTNOSTI / ELECTRICAL PROPERTIES / ELEKTRISCHE EIGENSCHAFTEN
---

MĚŘICÍ PODMÍNKY TEST CONDITIONS MESSBEDINGUNGEN	10 kHz, 50 mV, 25 °C	<b>L<sub>o</sub></b>	<b>1,2</b>	<b>mH</b>	<b>-30+40%</b>
	< 60 °C	<b>I<sub>N</sub></b>	<b>3,0</b>	<b>A</b>	<b>max</b>
	25 °C	<b>R<sub>DC</sub></b>	<b>40</b>	<b>mΩ</b>	<b>typ</b>

JINÉ VLASTNOSTI / OTHER PROPERTIES / ANDERE EIGENSCHAFTEN	
---	--

JÁDRO CORE KERN	<b>Ferit / Ferrite / Ferrit</b>	KLIMATICKÁ ODOLNOST CLIMATIC CATEGORY KLIMABESTÄNDIGKEIT	<b>40/125/21</b>	SCHVÁLENO APPROVED KONTROLLIERT
POUZDRO CASE GEHÄUSE	<b>UL94V-0</b>	ZKUŠEBNÍ NAPĚTÍ TESTING VOLTAGE PRÜFSPANNUNG	<b>1500 V<sub>ef</sub>, 50 Hz</b>	
ZALITÍ RESIN VERGUß	<b>UL94V-0</b>	JMENOVITÉ NAPĚTÍ RATED VOLTAGE NENNSPANNUNG	<b>250 V<sub>ef</sub>, 50 Hz</b>	
DRÁT WIRE DRAHT	<b>UL94V-0</b>	OTEPLENÍ OVERTEMPERATURE ÜBERTEMPERATUR	<b>&lt; 55 °C</b>	
		IZOLAČNÍ ODPOR INSULATING RESISTANCE ISOLATIONSWIDERSTAND	<b>50 MΩ, 500 V<sub>DC</sub></b>	

THE CHOKES ARE DESIGNED AND TESTED IN ACCORDANCE WITH EN 60938-1.  
 THE CASES ARE OF FLAME-RETARDANT PLASTIC MATERIAL IN ACCORDANCE WITH UL 94V-0.